

# Solid State Relays Zero Switching Types RGC Solid State Contactor 'E' Connection

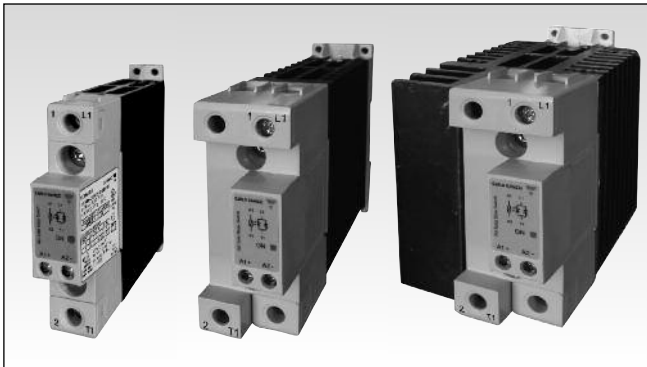

- Product Width ranging from 17.5mm up to 70mm
- Rated Operational voltage: Up to 600VAC
- Rated Operational current: Up to 85AAC @ 40°C
- Up to 6600A<sup>2</sup>s for I<sup>2</sup>t and 1200Vp blocking voltage
- Control voltages: 3-32 VDC, 20-275 VAC (24-190 VDC)
- IP20 protection
- Design according to EN/IEC60947-4-2, EN/IEC60947-4-3, EN/IEC62314, UL508, CSA 22-2 No. 14-10
- Integrated voltage transient protection with varistor
- RoHS compliant
- Short circuit current rating: 100kA
- VDE approval
- Germanischer Lloyd approval<sup>1</sup>

## Product Description

This new range of solid state contactors presents a unique opportunity to maximize efficiency in panel space and is an evolution of solid state switches for which Carlo Gavazzi is very well known.

The nominal current ratings are at 40°C. The smallest width is 17.5mm and is rated at 20 AAC. Power and control terminals allow for safe looping of cables.

Voltage transient protection is standard across the output with a varistor. Specifications are stated at 25°C unless otherwise noted.

1. Germanischer Lloyd approval applicable only to models RGC1....15.KE, RGC1...20.KE and RGC1....30.KE

## Ordering Key RGC 1 A 60 A 30 K K E

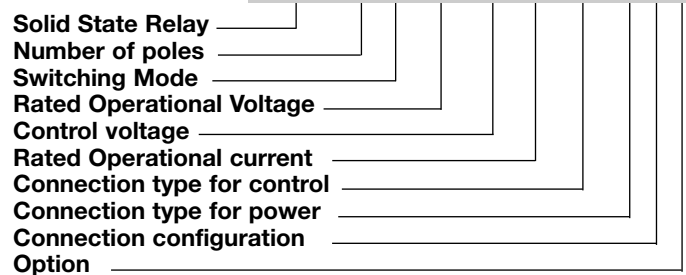

## Ordering Key

1Phase SSR with heatsink	Rated Voltage	Control Voltage	Rated Current <sup>2</sup>	Connection Control	Connection Power	Connection Configuration	Option
RGC1A: ZC	23: 230V +10% -15%, 800Vp	D: 3 or 4-32VDC	15: 20AAC	K: Screw	K: Screw	E: Contactor	P: Overtemperature protection <sup>3</sup>
RGC1B: IO	60: 600V +10% -15%, 1200Vp	A: 20 - 275VAC, 24-190 VDC	20: 23AAC 30: 30AAC 40: 40AAC 60: 60AAC 90: 85AAC	G: Box clamp M: Pluggable spring-loaded	G: Box Clamp		

2. Refer to derating curves

3. Default control connection for RGC...P is Box Clamp. See connections specifications.

## Selection Guide (ZC= Zero Cross Switching, IO = Instant-On Switching, OTP= Over Temperature Protection )

Rated Output Voltage	Blocking Voltage	Connection Control/ Power	Control Voltage	Rated Operational Current @ 40°C				
				20 AAC	23 AAC	23AAC + OTP	30 AAC	30AAC + OTP
230VAC, ZC	800Vp	Screw <sup>3</sup> /Screw	3 - 32VDC <sup>4</sup>	RGC1A23D15KKE	RGC1A23D20KKE	RGC1A23D20GKEP	RGC1A23D30KKE	RGC1A23D30GKEP
		Spring/Screw	3 - 32VDC	RGC1A23D15MKE	RGC1A23D20MKE	-	RGC1A23D30MKE	-
		Screw /Screw	20 - 275VAC, 24 - 190VDC	RGC1A23A15KKE	RGC1A23A20KKE	-	RGC1A23A30KKE	-
		Spring/Screw	20 - 275VAC, 24 - 190VDC	RGC1A23A15MKE	RGC1A23A20MKE	-	RGC1A23A30MKE	-
600VAC, ZC	1200Vp	Screw <sup>3</sup> /Screw	4 - 32VDC <sup>4</sup>	RGC1A60D15KKE	RGC1A60D20KKE	RGC1A60D20GKEP	RGC1A60D30KKE	RGC1A60D30GKEP
		Spring/Screw	4 - 32VDC	RGC1A60D15MKE	RGC1A60D20MKE	-	RGC1A60D30MKE	-
		Screw <sup>3</sup> /Screw	20 - 275VAC, 24 - 190VDC	RGC1A60A15KKE	RGC1A60A20KKE	RGC1A60A20GKEP	RGC1A60A30KKE	RGC1A60A30GKEP
		Spring/Screw	20 - 275VAC, 24 - 190VDC	RGC1A60A15MKE	RGC1A60A20MKE	-	RGC1A60A30MKE	-
600VAC, IO	1200Vp	Screw/Screw	4 - 32VDC	RGC1B60D15KKE	RGC1B60D20KKE	-	RGC1B60D30KKE	-

4. DC control voltage range for RGC...D..P is 5 - 32VDC

## Selection Guide (ZC= Zero Cross Switching, IO = Instant-On Switching, OTP = Over Temperature Protection ) (cont)

Rated Output Voltage	Blocking Voltage	Connection Control/ Power	Control Voltage	Rated Operational Current @ 40°C			
				40AAC	40AAC + OTP	60AAC	60AAC + OTP
230VAC, ZC	800Vp	Screw/Box Clamp	3 - 32VDC	RGC1A23D40KGE	-	RGC1A23D60KGE	-
		Spring/Box Clamp	3 - 32VDC	RGC1A23D40MGE	-	-	-
		Screw/Box Clamp	20 - 275VAC, 24 - 190VDC	RGC1A23A40KGE	-	RGC1A23A60KGE	-
		Spring/Box Clamp	20 - 275VAC, 24 - 190VDC	RGC1A23A40MGE	-	-	-
600VAC, ZC	1200Vp	Screw <sup>3</sup> /Box Clamp	4 - 32VDC <sup>4</sup>	RGC1A60D40KGE	RGC1A60D40GGEP	RGC1A60D60KGE	RGC1A60D60GGEP
		Spring/Box Clamp	4 - 32VDC	RGC1A60D40MGE	-	-	-
		Screw <sup>3</sup> /Box Clamp	20 - 275VAC, 24 - 190VDC	RGC1A60A40KGE	RGC1A60A40GGEP	RGC1A60A60KGE	RGC1A60A60GGEP
		Spring/Box Clamp	20 - 275VAC, 24 - 190VDC	RGC1A60A40MGE	-	-	-
600VAC, IO	1200Vp	Screw/Box Clamp	4 - 32VDC	RGC1B60D40KGE	-	RGC1B60D60KGE	-

Rated Output Voltage	Blocking Voltage	Connection Control/ Power	Control Voltage	Rated Operational Current @ 40°C
				85AAC + fan + OTP
230VAC, ZC	800Vp	Box Clamp/Box Clamp	5 - 32VDC	RGC1A23D90GGEP
600VAC, ZC	1200Vp	Box Clamp/Box Clamp	5 - 32VDC	RGC1A60D90GGEP
		Box Clamp/Box Clamp	20 - 275VAC, 24 - 190VDC	RGC1A60A90GGEP

3. Default control connection for RGC...P is Box Clamp. See connections specifications.

4. DC control voltage range for RGC..D..P is 5 - 32VDC

## Output Voltage Specifications

	RGC..23..	RGC..60..
Operational Voltage Range	24-240 VAC, +10%, -15% on max	42-600 VAC, +10% -15% on max
Blocking Voltage	800Vp	1200 Vp
Internal Varistor	275V	625V

## General Specifications

Latching voltage (across L1-T1)	≤20V	Over-voltage category	III (fixed installations)
Operational frequency range	45 to 65Hz	Isolation	
Power factor	> 0.5 @ Vrated	Input to Output RGC...	4000 Vrms
Finger Protection	IP20	RGC...D..P	2500 Vrms
Control input status	continuously ON Green LED, when control input is applied	RGC...A..P	4000 Vrms
Pollution degree	2 (non-conductive pollution with possibilities of condensation)	Input and Output to case RGC...	4000 Vrms
		RGC...D..P	4000 Vrms
		RGC...A..P	4000 Vrms
		Input to Fan/ Alarm Output RGC...A..P	2500 Vrms

## Output specifications (@ 25°C unless otherwise specified)

	RGC..15..	RGC..20..	RGC..30..	RGC..40..	RGC..60..	RGC..90..
Rated operational current <sup>6</sup>						
AC-51 rating @ Ta=25°C	20 AAC	25.5 AAC	30 AAC	47.4 AAC	70.4 AAC	85 AAC
AC-51 rating @ Ta=40°C	20 AAC	23 AAC	30 AAC	40 AAC	60 AAC	85 AAC
AC-53a rating @ Ta=40°C	5 AAC	5 AAC	8 AAC	13 AAC	14.8 AAC	18 AAC
Number of motor starts (x:6, Tx:6s, F:50%) at 40°C <sup>5</sup>	30	30	30	30	30	30
Min. operational current	150 mAAC	150 mAAC	250 mAAC	400 mAAC	400 mAAC	400 mAAC
Rep. overload current - (Motor Rating) PF = 0.4 - 0.5 UL508: T <sub>AMB</sub> =40°C, t <sub>ON</sub> =1s, t <sub>OFF</sub> =9s, 50cycles	60 AAC	60 AAC	84 AAC	126 AAC	144 AAC	168 AAC
Maximum transient surge current (I <sub>TSM</sub> )	325 Ap	325 Ap	600 Ap	800Ap	800Ap	1150Ap
Maximum off-state leakage current	3 mA	3 mA	3 mA	3 mA	3 mA	3 mA
I <sup>2</sup> t (10ms) Minimum	525 A <sup>2</sup> s	525 A <sup>2</sup> s	1800 A <sup>2</sup> s	3200A <sup>2</sup> s	3200A <sup>2</sup> s	6600A <sup>2</sup> s
Critical dv/dt (@ T <sub>j</sub> init = 25°C)	1000 V/us	1000 V/us	1000 V/us	1000 V/us	1000 V/us	1000 V/us

5. Overload current profile definition: x: multiple of AC53a rating, Tx: duration of current surge, F: duty cycle

6. See derating curves

## Overtemperature alarm specifications for RGC...P

	RGC..D..P	RGC..A..P
Output type	PNP open collector	Potential Free
Normal state	Closed	Closed
Maximum current rating	50 mADC	50 mADC
Rated voltage (EN61131-2: 2003) <sup>8,7</sup> , U <sub>a</sub>	24VDC -15%, +20%	24VDC -15%, +20%
Rated voltage, U <sub>s</sub>	RGC...D90GGEP 24VDC ± 10%	N/A
Fan rating, U <sub>f</sub>	RGC...A90GGEP N/A	24VDC ±10%, 50mA nominal
Alarm voltage drop	Typical Maximum 2.8VDC 4VDC	1.8VDC 3.5VDC
Visual Indication	Continous Red LED	Continous Red LED
Reverse polarity protection	24VDC	24VDC

7: DC supply for alarm signal should be supplied from a Class 2 power source

8: Maximum voltage to be applied between 11+ and 12- (U<sub>a</sub>) terminals should be 35VDC maximum with reference to A2-

## Input specifications

		RGC..D.. <sup>9</sup>	RGC..A..
Control voltage range <sup>10</sup>	RGC..23..	3 - 32 VDC	20 - 275 VAC, 24 (-10%) - 190 VDC
	RGC..60..	4 - 32 VDC	20-275 VAC, 24 (-10%) - 190 VDC
	RGC...P (Uc)	5 - 32 VDC	20-275 VAC, 24 (-10%) - 190 VDC
Pick-up voltage	RGC..23..	3.0 VDC	20 VAC/DC
	RGC..60..	3.8 VDC	
	RGC...P	5 VDC	20 VAC/ 24VDC
Drop-out voltage		1 VDC	5 VAC/DC
Maximum Reverse voltage		32 VDC	-
Response time pick-up ZC (RGC1A..)		0.5 cycle + 500µs @ 24VDC	2 cycles @ 230VAC/110VDC
Response time pick-up IO (RGC1B..)		350µs @ 24 VDC	N/A
Response time drop-out		0.5 cycle + 500µs @ 24VDC	0.5 cycle + 40ms @ 230VAC/ 110VDC
Input current @ 40°C		See diagrams below	See diagrams below

9. DC control to be supplied by class 2 power source

10. For GL approved models control range for RGC1.23... is 4-32VDC and for RGC1.60... 5-32VDC

RGC..A..

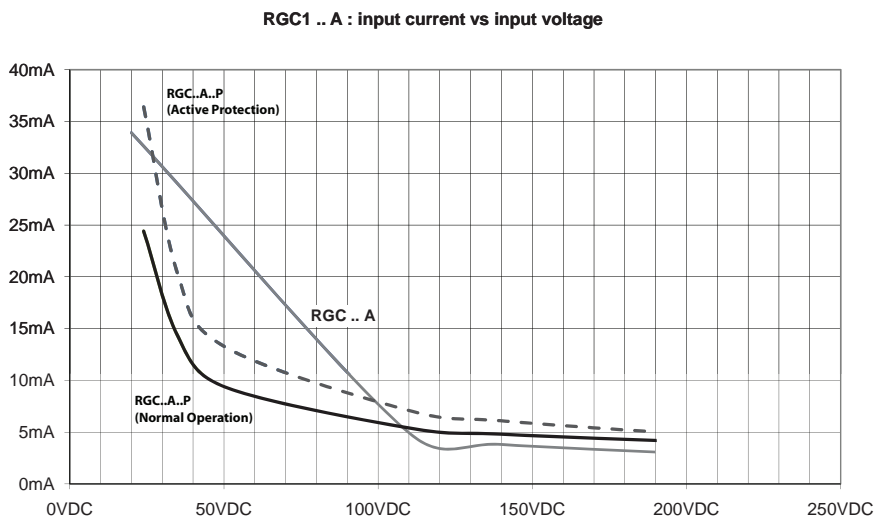
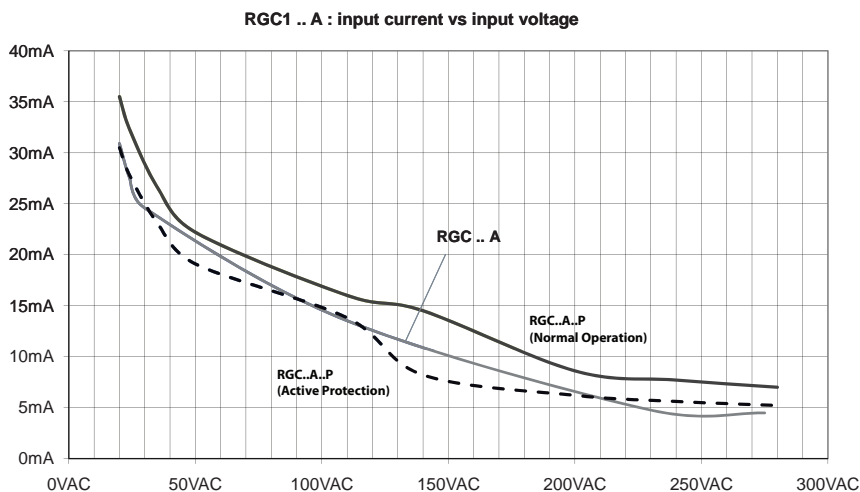

## Input specifications (cont.)

RG..D..

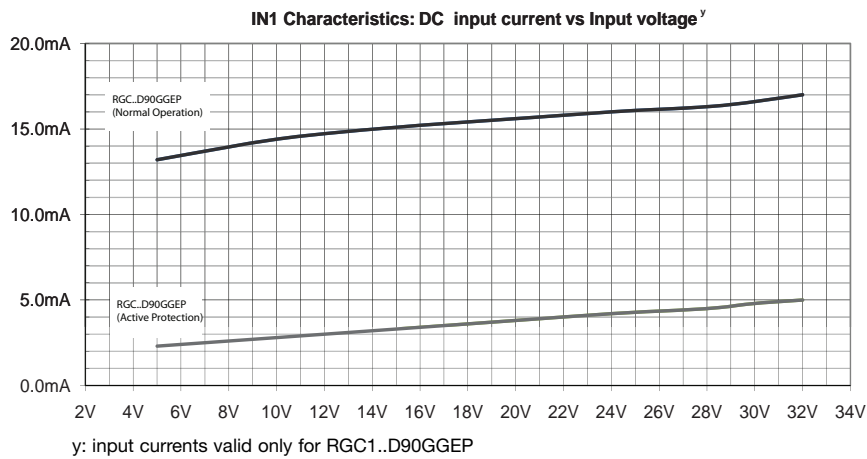
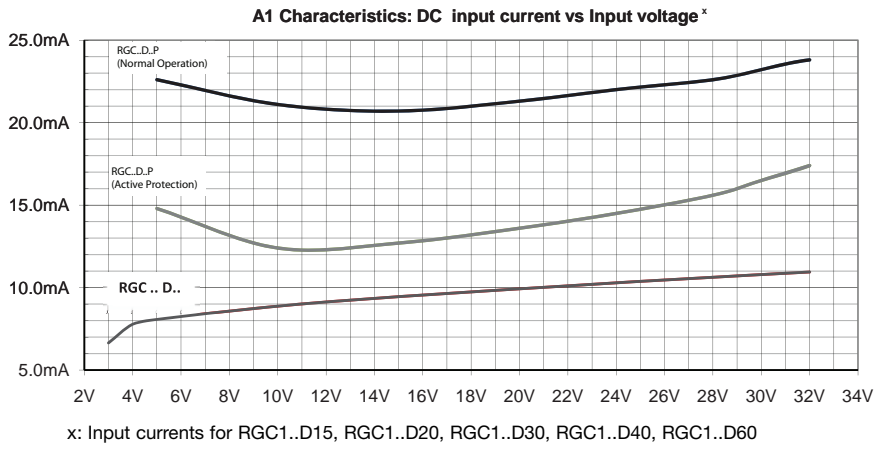

**Motor Ratings: HP (UL508) / kW (IEC60947-4-2) @ 40°C**

	115 VAC	230 VAC	400 VAC	480 VAC	600 VAC
RGC..15	1/3 HP / 0.18kW	1HP / 0.37kW	2HP / 0.75kW	3HP / 1.1kW	3HP / 1.5kW
RGC..20	1/2HP / 0.18kW	1-1/2HP / 0.37kW	2HP / 0.75kW	3HP / 1.1kW	3HP / 1.5kW
RGC..30	3/4HP / 0.37kW	2HP / 1.1kW	3HP / 1.5kW	5HP / 2.2kW	5HP / 3.7kW
RGC..40	1HP / 0.56kW	3HP / 1.5kW	5HP / 2.2kW	5HP / 3.7kW	7-1/2HP / 4kW
RGC..60	1-1/2HP / 0.56kW	3HP / 1.5kW	5HP / 3kW	7-1/2HP / 4kW	10HP / 4kW
RGC..90GGE	2HP / 0.75kW	5HP / 1.5kW	7-1/2HP / 4kW	10HP / 4kW	15HP / 5.5kW

**Detailed Over temperature Alarm Procedure (for RGC...P)**

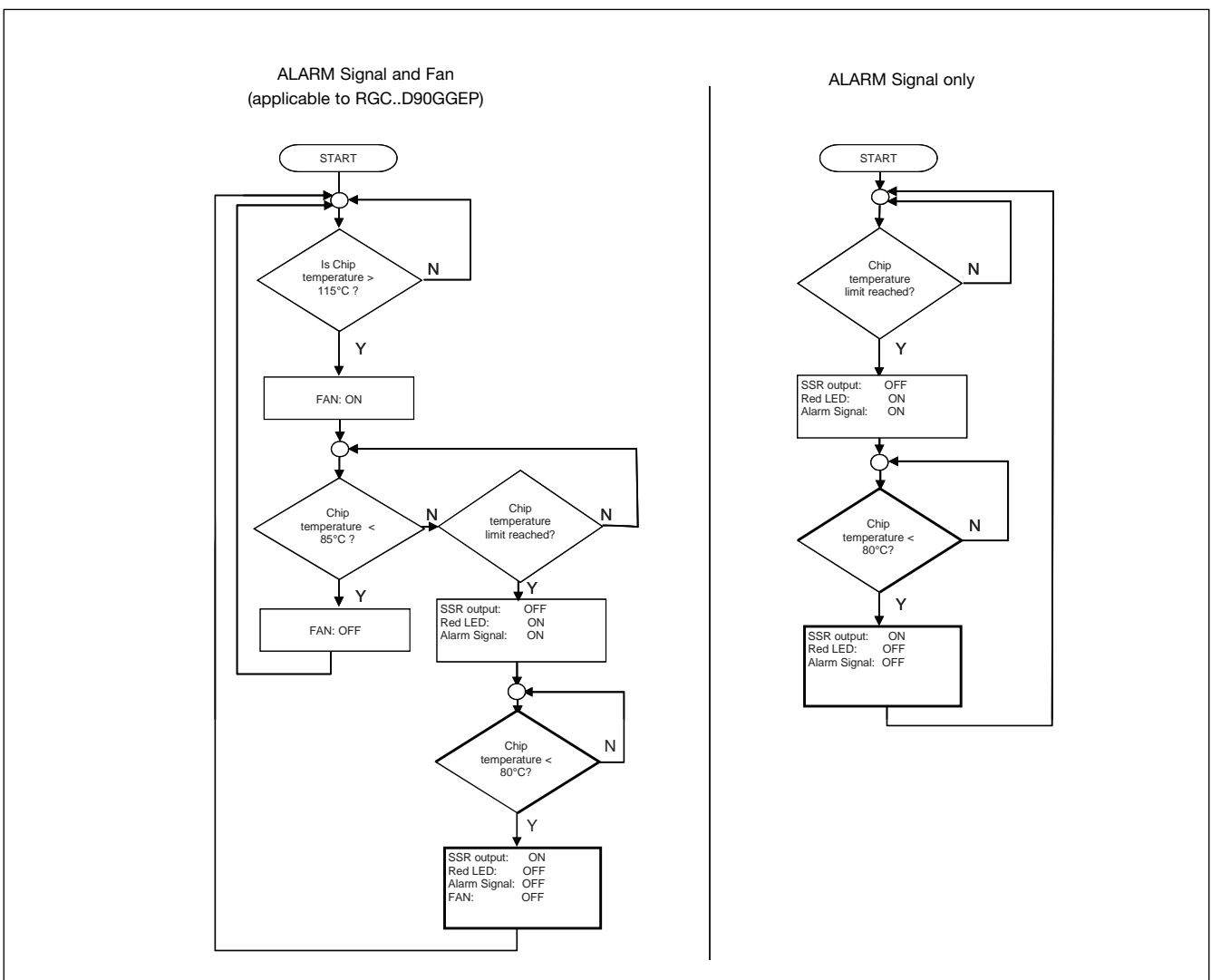

**CAUTION**

- Alarm condition resets whenever the voltage signal is removed from terminal A1 (+)
- In the case of RGC...D90GGE, if the voltage signal is not applied across A1(+) and A2 (-) terminals, the overtemperature detection and functionality is lost (including fan operation and alarm signalling)
- In the case of RGC1A60A90GGE it is necessary to supply IN2 and IN3 with 24VDC for fan operation.
- Alarm procedure for RGC1A60A90GGE follows 'Alarm signal only' flow since fan is continuously operating.
- Alarm condition automatically resets ONLY when power semiconductor temperature < 80°C
- Temperatures indicated are typical figures.

## Output Power Dissipation

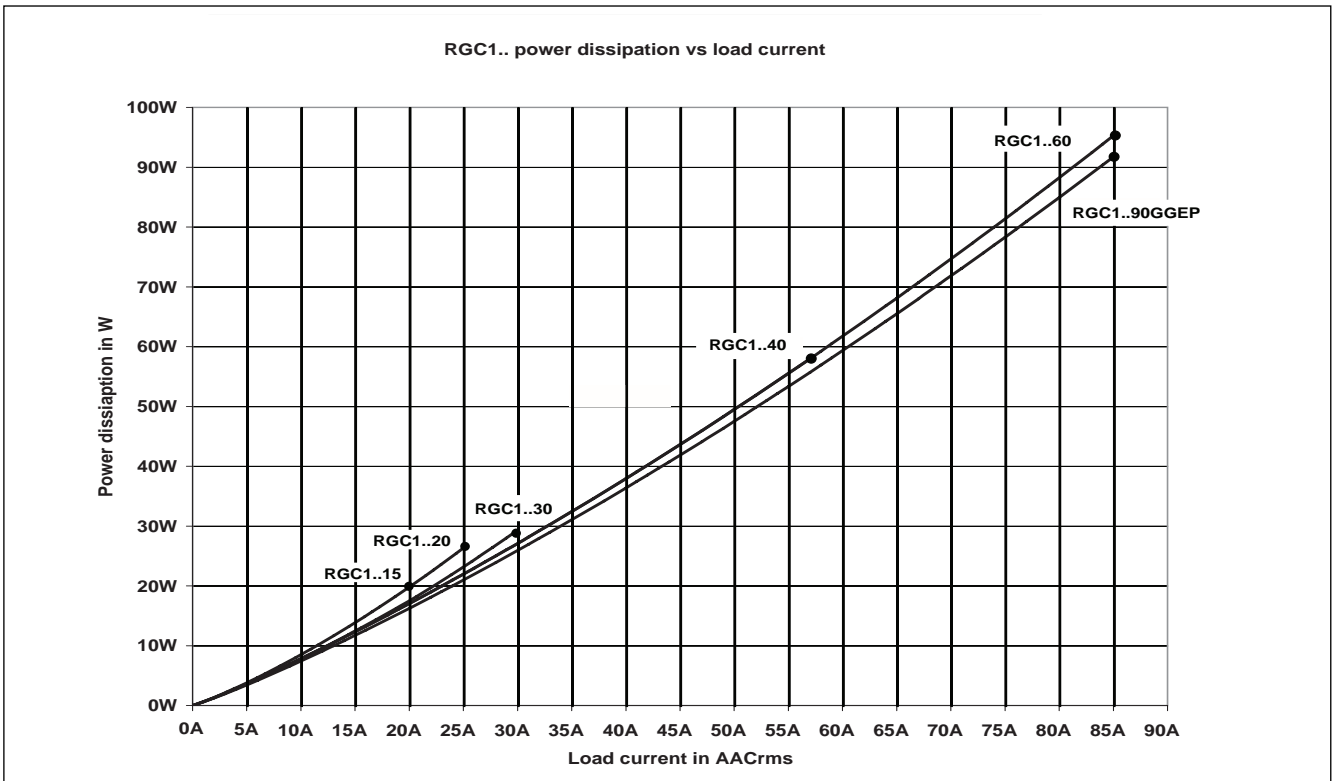

## Current Derating (UL508)

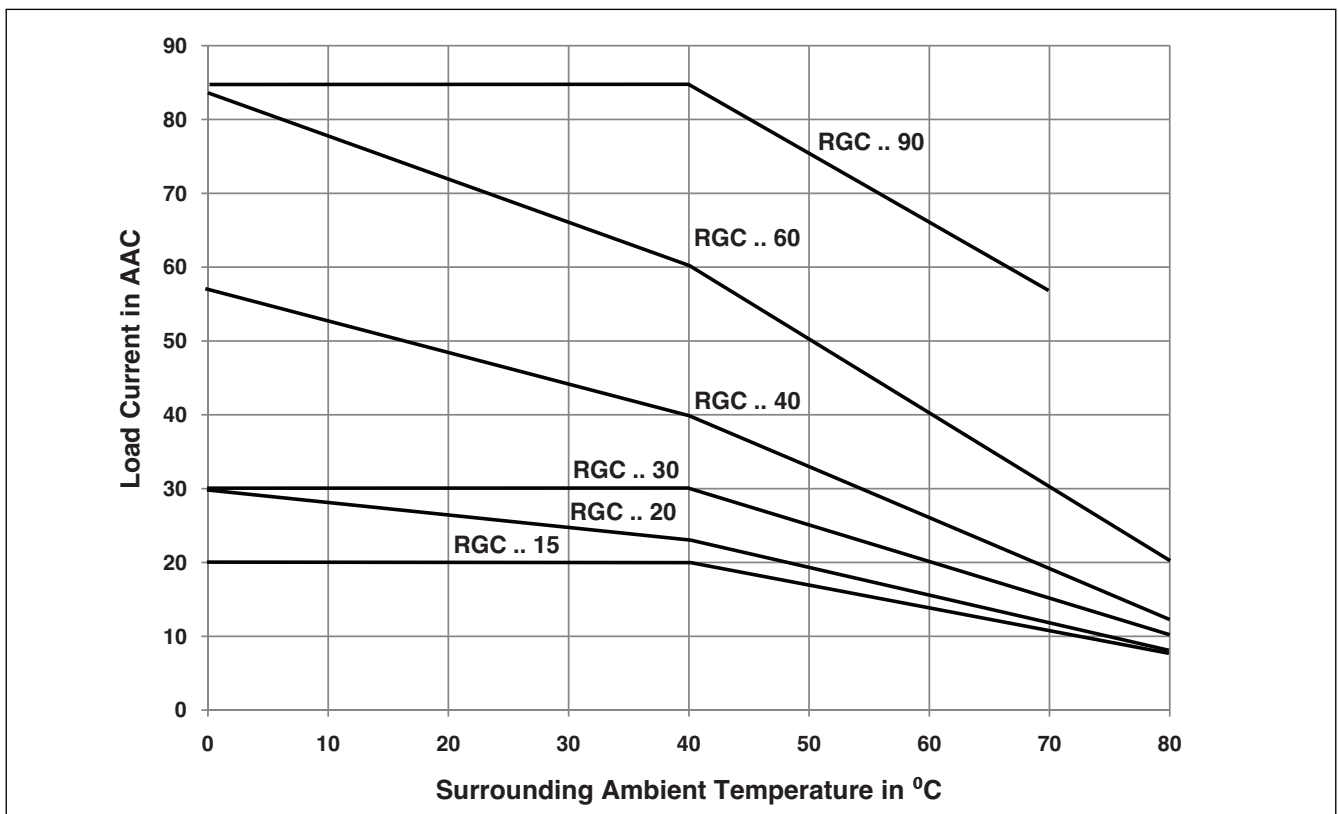

RGC...P models max. operating temperature is + 70°C

## Derating vs. Spacing Curves

RGC.. 15..

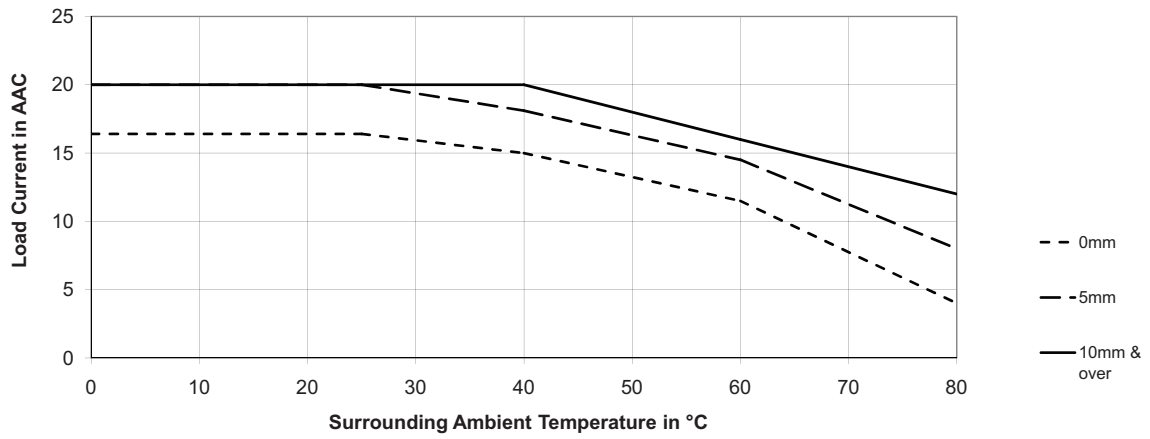

RGC.. 20..

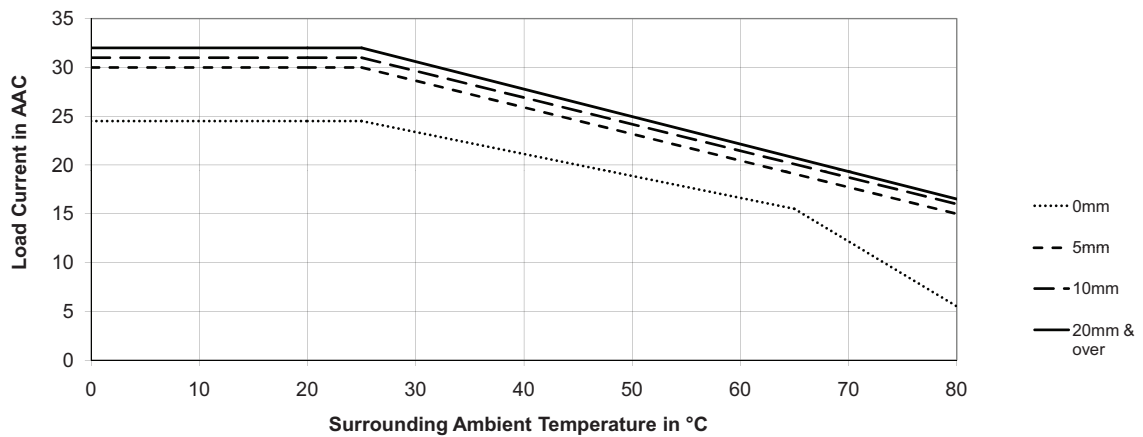

RGC.. 30..

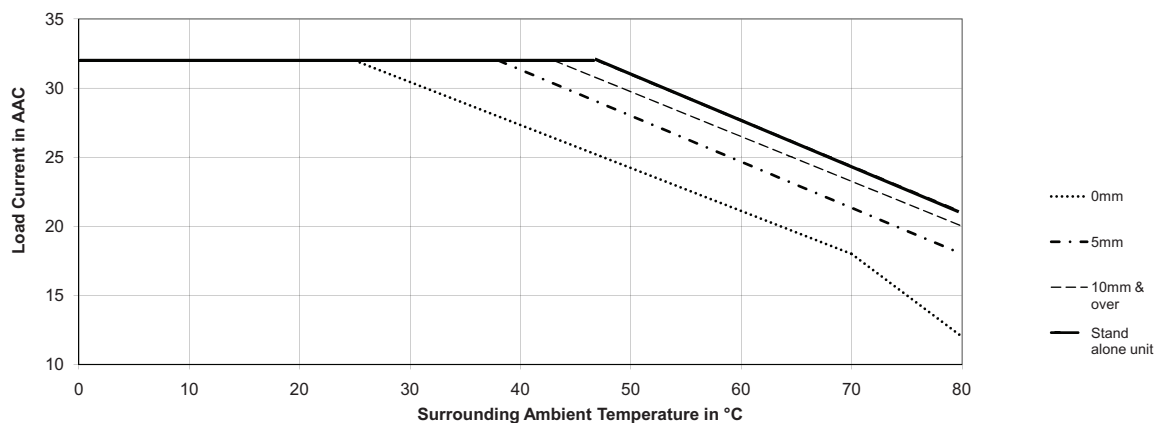



## Derating vs. Spacing Curves

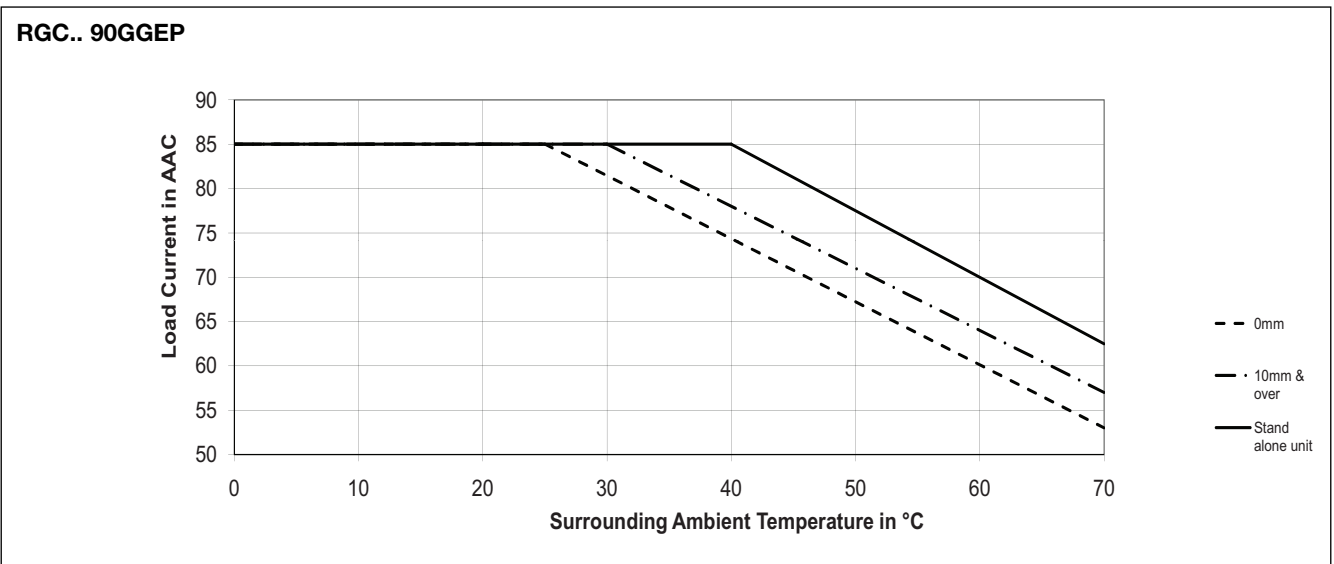
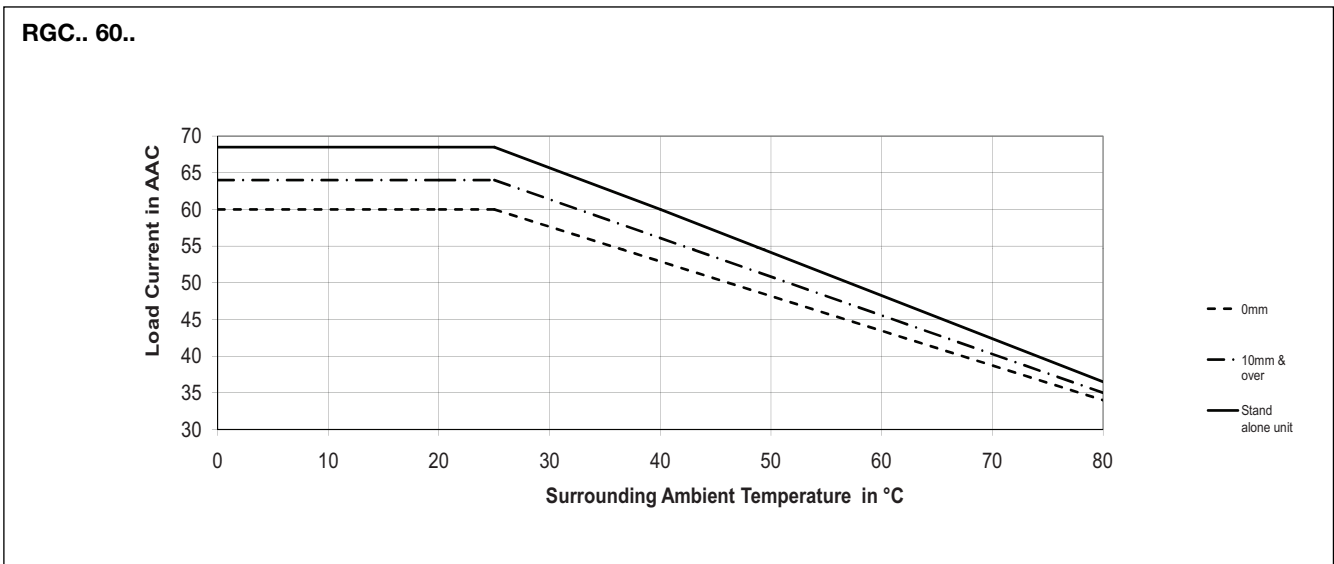
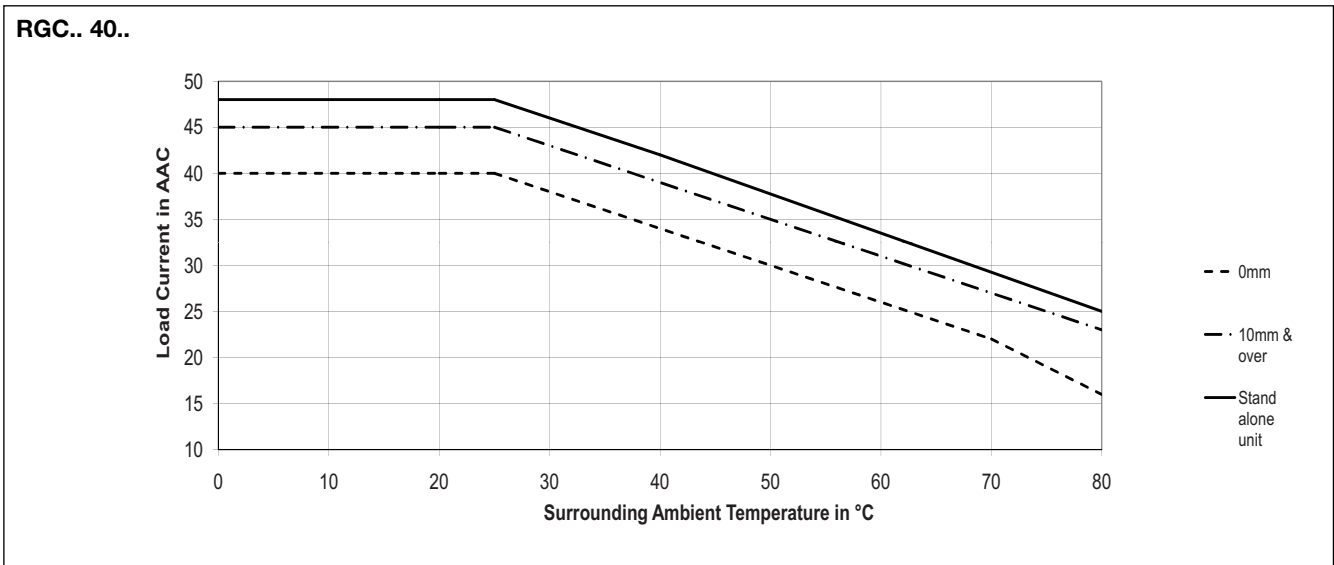

## Agency Approvals and Conformances

<b>Conformance</b>	IEC/EN 62314 IEC/EN 60947-4-2 IEC/EN 60947-4-3	<b>Agency Approvals</b>	UL508 Listed (E172877) cUL Listed (E172877) VDE 0660-109 GL <sup>12</sup>
		<b>Short Circuit Current Rating</b>	100kA, UL508



## Electromagnetic Compatibility

<b>EMC Immunity</b>	IEC/EN 61000-6-2	<b>Electrical Surge Immunity</b> (for RGC...EP)	IEC/EN 61000-4-5
<b>Electrostatic Discharge (ESD) Immunity</b>	IEC/EN 61000-4-2	Output, line to line, 1kV	Performance Criteria 1
Air discharge, 8kV	Performance Criteria 1	Output, line to earth, 2kV	Performance Criteria 1
Contact, 4kV	Performance Criteria 1	DC lines, line to line, 500V	Performance Criteria 2
<b>Electrical Fast Transient (Burst) Immunity</b>	IEC/EN 61000-4-4	DC lines, line to earth, 500V	Performance Criteria 2
Output: 2kV, 5kHz	Performance Criteria 1	Signal lines, line to earth, 1kV	Performance Criteria 2
Input: 1kV, 5kHz	Performance Criteria 1	<b>Radiated Radio Frequency Immunity</b>	IEC/EN 61000-4-3
<b>Electrical Surge Immunity</b> (for RGC...E)	IEC/EN 61000-4-5	10V/m, 80 - 1000 MHz	Performance Criteria 1
Output, line to line, 1kV	Performance Criteria 1	10V/m, 1.4 - 2 GHz	Performance Criteria 1
Output, line to earth, 2kV	Performance Criteria 1	3V/m, 2 - 2.7 GHz	Performance Criteria 1
Input, line to line, 1kV	Performance Criteria 2	<b>Conducted Radio Frequency Immunity</b>	IEC/EN 61000-4-6
Input, line to earth, 2kV	Performance Criteria 2	10V/m, 0.15 - 80 MHz	Performance Criteria 1
<b>EMC Emission</b>	IEC/EN 61000-6-4	<b>Voltage Dips Immunity</b>	IEC/EN 61000-4-11
<b>Radio Interference</b>		0% for 10ms/20ms,	Performance Criteria 2
<b>Voltage Emission (Conducted)</b> 0.15 - 30MHz	IEC/EN 55011 Class A (industrial) with filters - see filter information IEC/EN 60947-4-2, 60947-4-3 Class A (no filtering needed)	40% for 200ms	Performance Criteria 2
		70% for 500ms	Performance Criteria 2
		<b>Voltage Interruptions Immunity</b>	IEC/EN 61000-4-11
		0% for 5000ms	Performance Criteria 2
		<b>Radio Interference</b> <b>Field Emission (Radiated)</b> 30 - 1000MHz	IEC/EN 55011 Class A (industrial)

## Environmental Specifications

Operating Temperature <sup>11</sup>	-40°C to 80°C (-40°F to +176°F)	Vibration resistance (2-100Hz, IEC60068-2-26, EN50155, EN61373)	2g per axis
Storage Temperature	-40°C to 100°C (-40°F to +212°F)	Relative humidity	95% non-condensing @ 40°C
RoHS (2002/95/EC)	Compliant	UL flammability rating (housing)	UL 94 V0
Impact resistance (EN50155, EN61373)	15/11 g/ms		

11. Operating temperature range for RGC..P (overtemperature protection) is -30°C to 70°C (-22°F to 158°F)

12. Applicable to models RGC1...15.KE, RGC1...20.KE and RGC1...30.KE

## Filtering - EN / IEC 55011 Class A compliance (for class B compliance contact us)

Part Number	Suggested filter for compliance	Maximum Heater current
RGC1A23..15	68nF / 275 V / X1	20A
RGC1A23..20	68nF / 275 V / X1	20A
RGC1A23..30	220 nF / 275V / X1	30A
RGC1A23..40	220 nF / 275V / X1 330 nF / 275V / X1	30A 45A
RGC1A23..60	220 nF / 275V / X1 330 nF / 275V / X1	30A 45A
RGC1A23..90GGEP	330 nF / 275V / X1 470 nF / 275V / X1	35A 65A
RGC1A60..15	100 nF / 760V / X1	20A
RGC1A60..20	100 nF / 760V / X1	20A
RGC1A60..30	220 nF / 760V / X1	30A
RGC1A60..40	220 nF / 760V / X1 330 nF / 760V / X1	25A 45A
RGC1A60..60	220 nF / 760V / X1 330 nF / 760V / X1	25A 45A
RGC1A60..90GGEP	330 nF / 760V / X1 470 nF / 760V / X1	40A 65A

Note:

- Control input lines must be installed together to maintain products' susceptibility to Radio Frequency interference.
- Use of AC solid state relays may, according to the application and the load current, cause conducted radio interferences. Use of mains filters may be necessary for cases where the user must meet E.M.C requirements. The capacitor values given inside the filtering specification tables should be taken only as indications, the filter attenuation will depend on the final application.
- Performance Criteria 1: No degradation of performance or loss of function is allowed when the product is operated as intended.
- Performance Criteria 2: During the test, degradation of performance or partial loss of function is allowed. However when the test is complete the product should return operating as intended by itself.
- Performance Criteria 3: Temporary loss of function is allowed, provided the function can be restored by manual operation of the controls.

## Filter Connection Diagrams

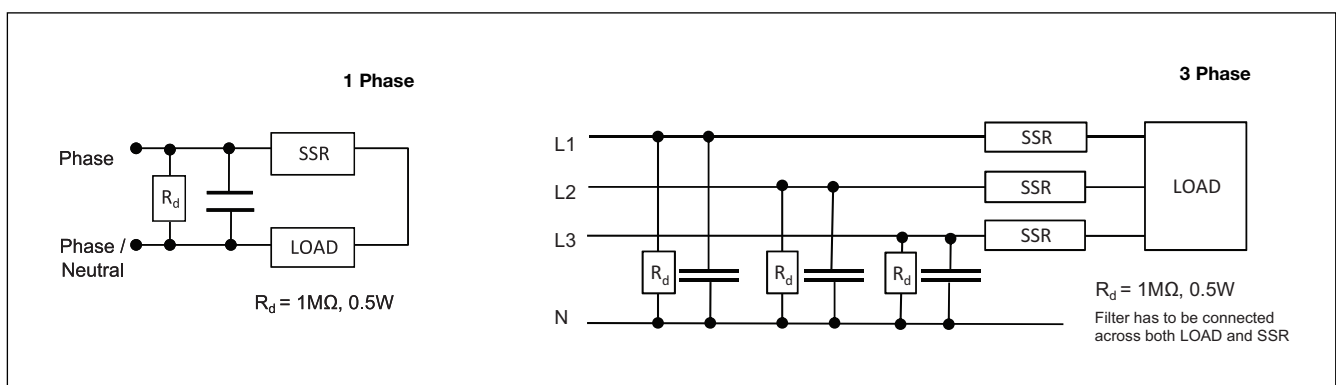

## Connection Diagram (No OTP)

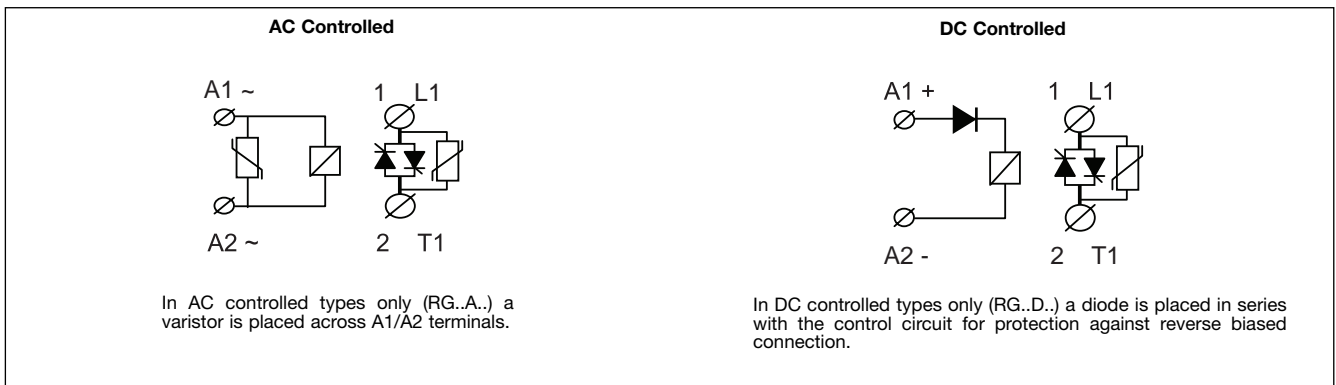

## Connection Diagram (with OTP)

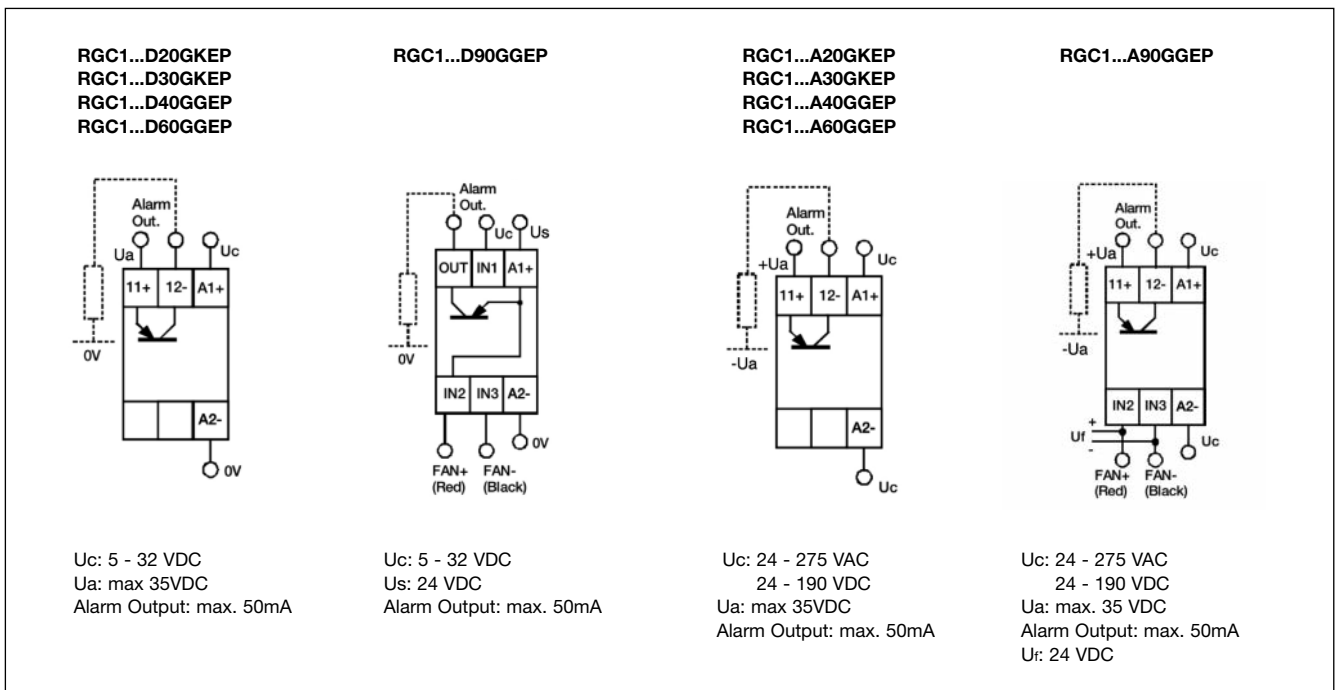

## Terminal Layout and Dimensions

### RGC...15KKE

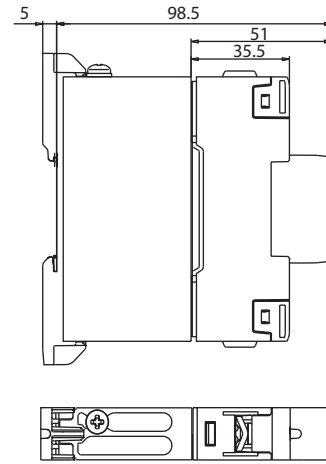
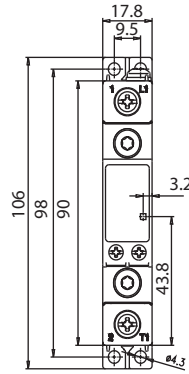
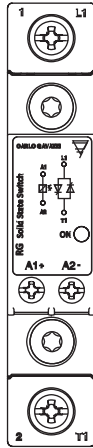

### RGC...15MKE

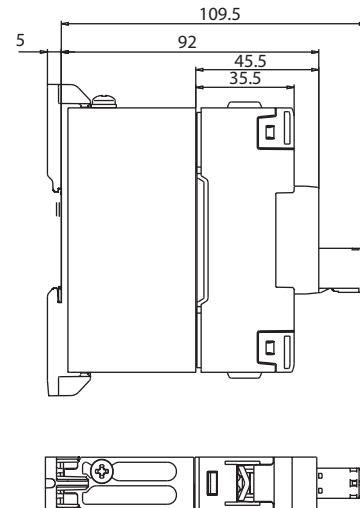
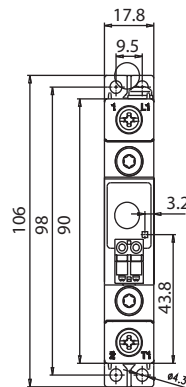
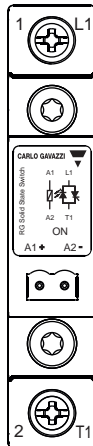

1/L1: Supply connection  
 2/T1: Load connection  
 A1 (+): Positive control signal  
 A2 (-): Control ground

\* Housing width tolerance +0.5mm, -0mm...as per DIN43880  
 All dimensions in mm

## Terminal Layout and Dimensions (cont.)

RGC...20KKE

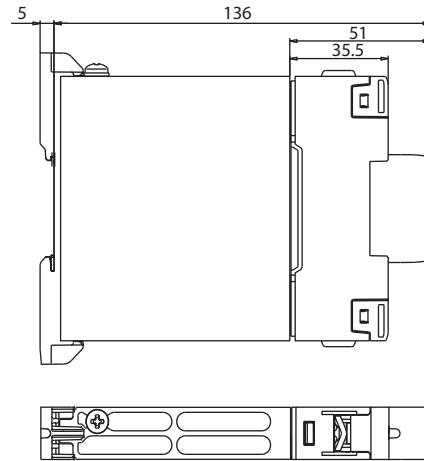
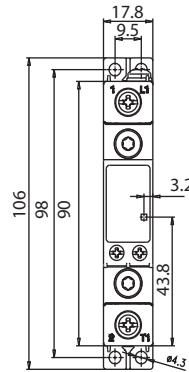
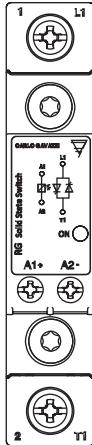

RGC...20MKE

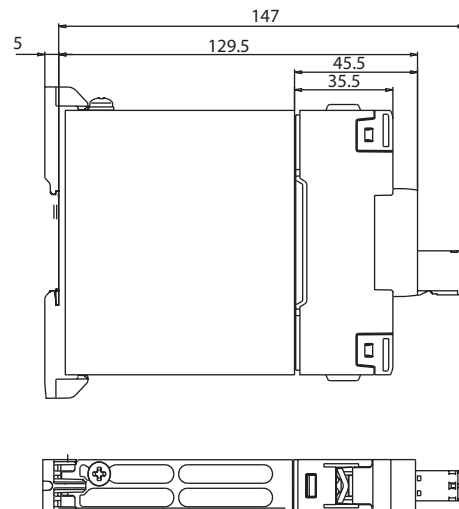
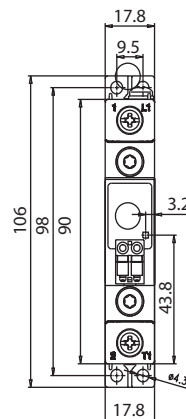
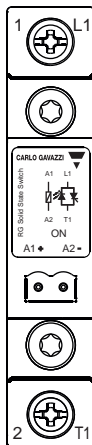

RGC...30KKE

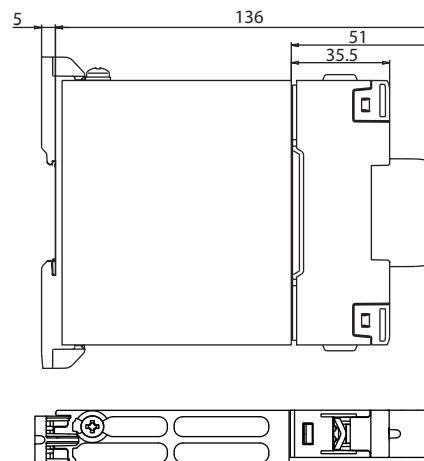
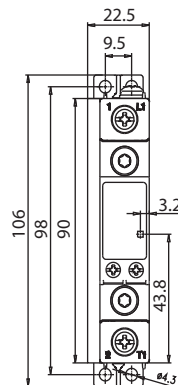
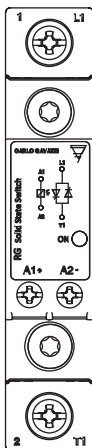

1/L1: Supply connection  
 2/T1: Load connection  
 A1 (+): Positive control signal  
 A2 (-): Control ground

\* Housing width tolerance +0.5mm, -0mm...as per DIN43880  
 All dimensions in mm

## Terminal Layout and Dimensions (cont.)

RGC...30MKE

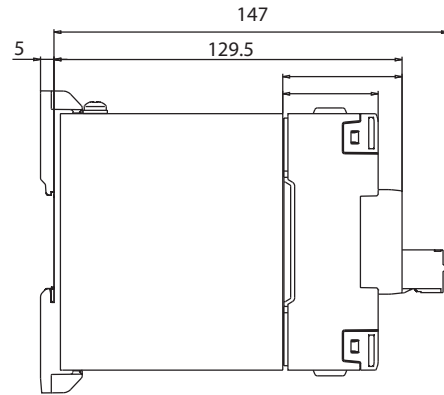
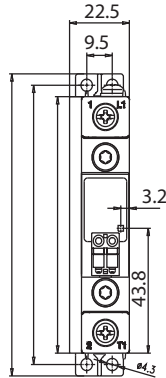
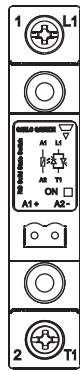

RGC...40KGE

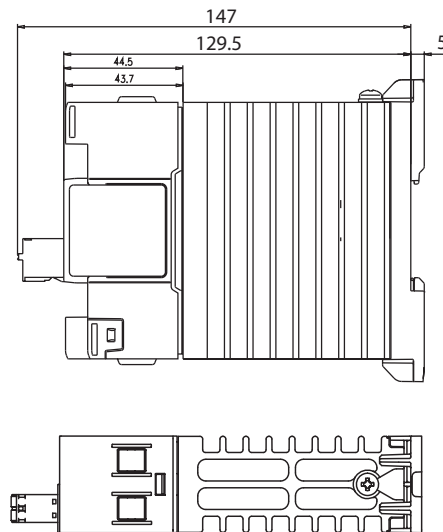
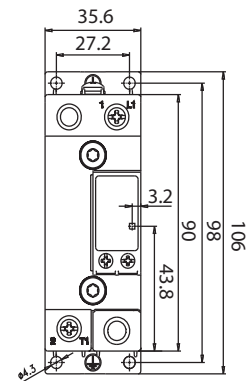
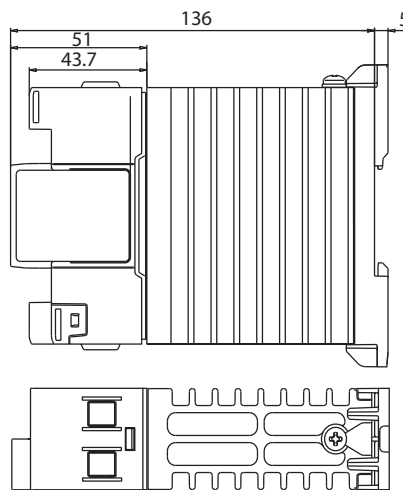
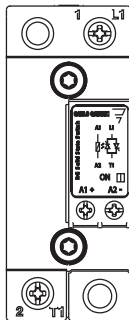

RGC...40MGE

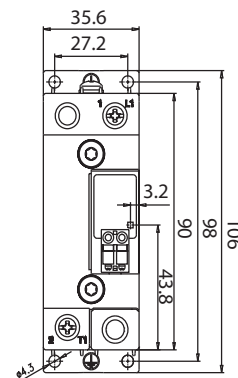
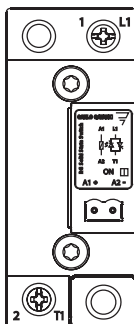

1/L1: Supply connection  
 2/T1: Load connection  
 A1 (+): Positive control signal  
 A2 (-): Control ground

\* Housing width tolerance +0.5mm, -0mm...as per DIN43880  
 All dimensions in mm

## Terminal Layout and Dimensions (cont.)

RGC...60KGE

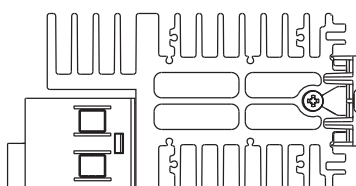
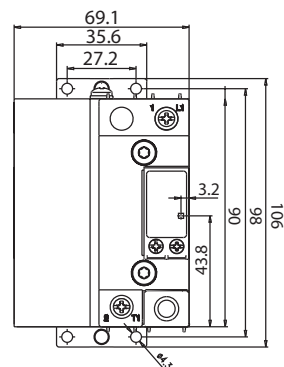
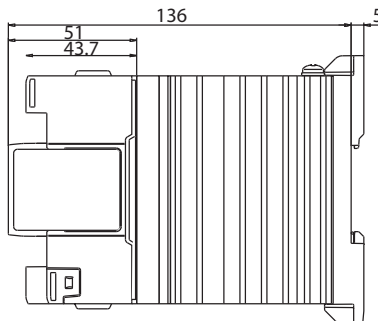
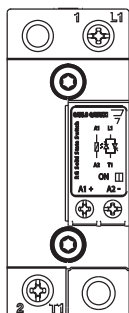

RGC...20GKEP

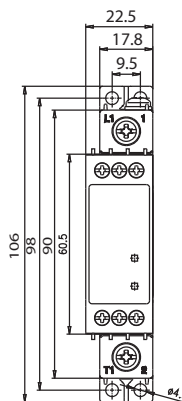
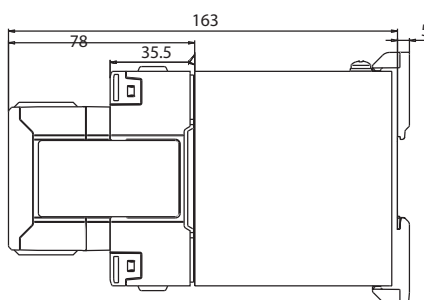

RGC...30GKEP

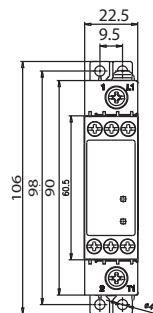
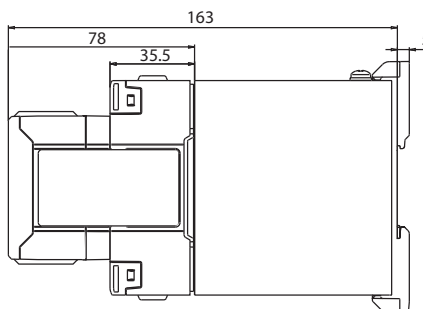

- 1/L1: Supply connection
- 2/T1: Load connection
- A1 (+): Positive control signal  
(Positive supply in case of RGC1A..D90GGEP)
- A2 (-): Control ground
- IN1: Control signal (only for RGC1A.. D 90GGEP)
- IN2: Fan + supply (only for RGC1A60A90GGEP)
- IN3: Fan - supply (only for RGC1A60A90GGEP)
- 11 + : Alarm output (+)
- OUT, 12 - : Alarm output (-)

\* Housing width tolerance +0.5mm, -0mm...as per DIN43880  
All dimensions in mm



## Terminal Layout and Dimensions (cont.)

### RGC...40GGEP

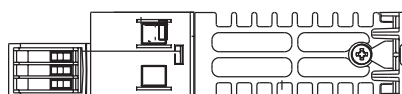
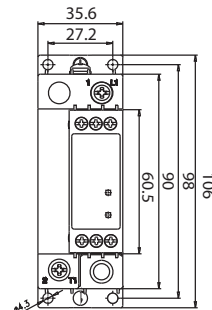
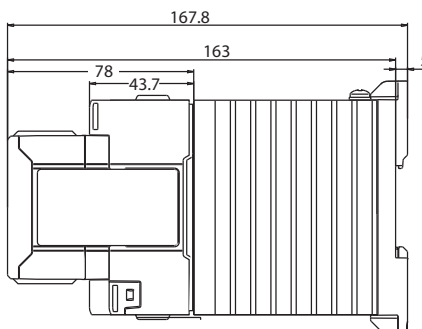
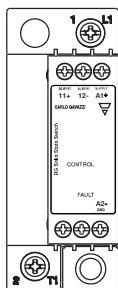

### RGC...60GGEP

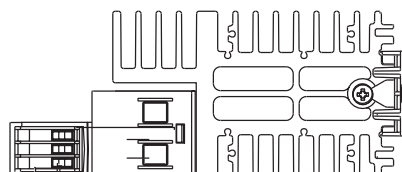
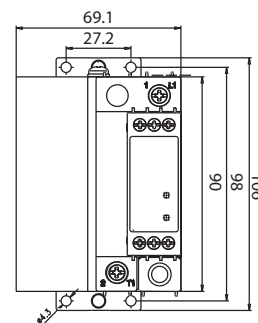
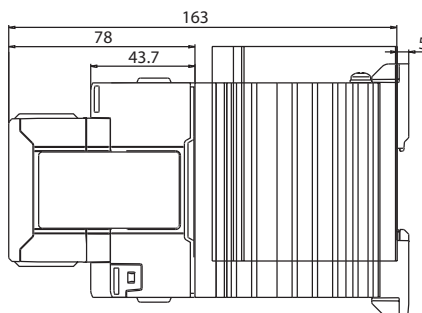
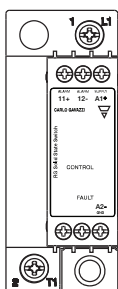

### RGC...90GGEP

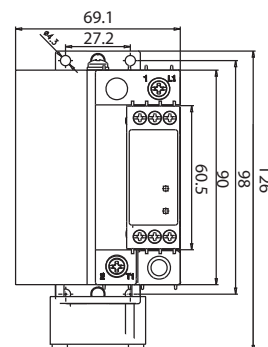
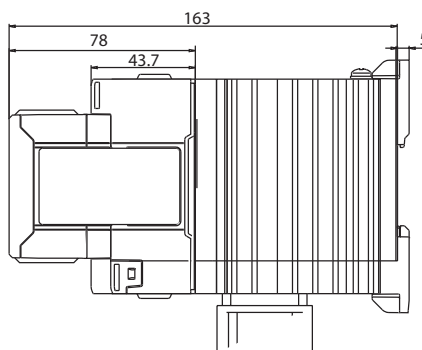
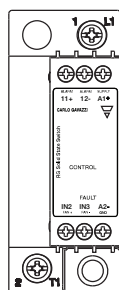
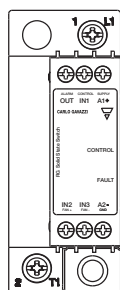

RGC...D90GGEP

RGC...A90GGEP





- 1/L1: Supply connection
- 2/T1: Load connection
- A1 (+): Positive control signal  
(Positive supply in case of RGC1A..D90GGEP)
- A2 (-): Control ground
- IN1: Control signal (only for RGC1A..D90GGEP)
- IN2: Fan + supply (only for RGC1A60A90GGEP)
- IN3: Fan - supply (only for RGC1A60A90GGEP)
- 11 + : Alarm output (+)
- OUT, 12 - : Alarm output (-)

\* Housing width tolerance +0.5mm, -0mm...as per DIN43880  
All dimensions in mm

## Connection Specifications

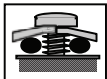
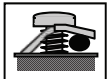
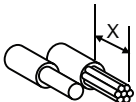
### POWER CONNECTIONS: 1/L1, 2 /T1

Use 75°C copper (Cu) conductors

	RGC..15.KE ; RGC..20.KE ; RGC..30.KE.	RGC..40.GE ; RGC..60.GE ; RGC..90GGEP
<b>Stripping Length (X)</b>	12mm	11mm
<b>Connection type</b>	M4 screw with captivated washer	M5 screw with box clamp
<b>Rigid (Solid &amp; Stranded)</b> UL/ cUL rated data	 2 x 2.5..6 mm <sup>2</sup> 2 x 14.. 10 AWG	 1 x 2.5..6 mm <sup>2</sup> 1 x 14.. 10 AWG
<b>Flexible with end sleeve</b>	 2 x 1.0 ... 2.5mm <sup>2</sup> 2 x 2.5..4mm <sup>2</sup> 2 x 18.. 14 AWG 2 x 14.. 12 AWG	 1 x 2.5..16mm <sup>2</sup> 1 x 10..3 AWG
<b>Flexible without end sleeve</b>	 2 x 1.0 ... 2.5mm <sup>2</sup> 2 x 2.5.. 6mm <sup>2</sup> 2 x 18.. 14 AWG 2 x 14.. 10 AWG	 1 x 4.. 25mm <sup>2</sup> 1 x 12.. 3 AWG
<b>Torque specifications</b>	 2 Nm (17.7 in-lb). M4, Pozidriv 2	 2.5 Nm (22 in-lb). M5, Pozidriv 2
<b>Aperture for termination lug</b>	12.3mm	N/A

### Protective Earth Connection







RGC..15, 20: M4, 1.5Nm (13.3 in-lb)  
RGC..30, 40, 60, 90: M5, 1.5Nm (13.3 in-lb)

Note: Protective Earth connection must be connected whenever the product is intended to be used in Class 1 applications according to EN/IEC 61140.

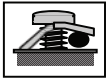
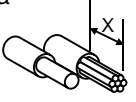

### CONTROL CONNECTIONS: A1(+), A2(-)

Use 60/75°C copper (Cu) conductors

	RGC..K.E	RGC...M.E
<b>Torque specifications</b>	 0.5 Nm (4.4 in-lb); M3, Pozidriv 1	
<b>Stripping Length (X)</b>	8mm	12 - 13mm
<b>Rigid (Solid &amp; Stranded)</b> UL/ cUL rated data	 2 x 0.5..2.5mm <sup>2</sup> 2 x 18..12 AWG	 1 x 0.5..2.5mm <sup>2</sup> 1 x 18..12 AWG
<b>Flexible with end sleeve</b>	 2 x 0.5..2.5mm <sup>2</sup> 2 x 18..12AWG	 1 x 0.2...2.5mm <sup>2</sup> 1 x 24...12 AWG

### CONTROL CONNECTIONS: A1(+), A2(-), IN1, IN2, IN3, 11 (+), 12(-), OUT

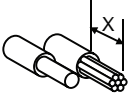
Use 60/75°C copper (Cu) conductors

	RGC...GGEP	
<b>Torque specifications</b>	 0.5 Nm (4.4 in-lb); M3, Pozidriv 1	
<b>Stripping Length (X)</b>	6mm	13mm
<b>Rigid (Solid &amp; Stranded)</b> UL/ cUL rated data	 2 x 0.5..2.5mm <sup>2</sup> 2 x 18..12 AWG	 1 x 0.2..2.5mm <sup>2</sup> 1 x 24..12 AWG
<b>Flexible with end sleeve</b>	 2 x 0.5..2.5mm <sup>2</sup> 2 x 18..12AWG	 1 x 0.2..2.5mm <sup>2</sup> 1 x 24..12AWG

## Installation Instructions

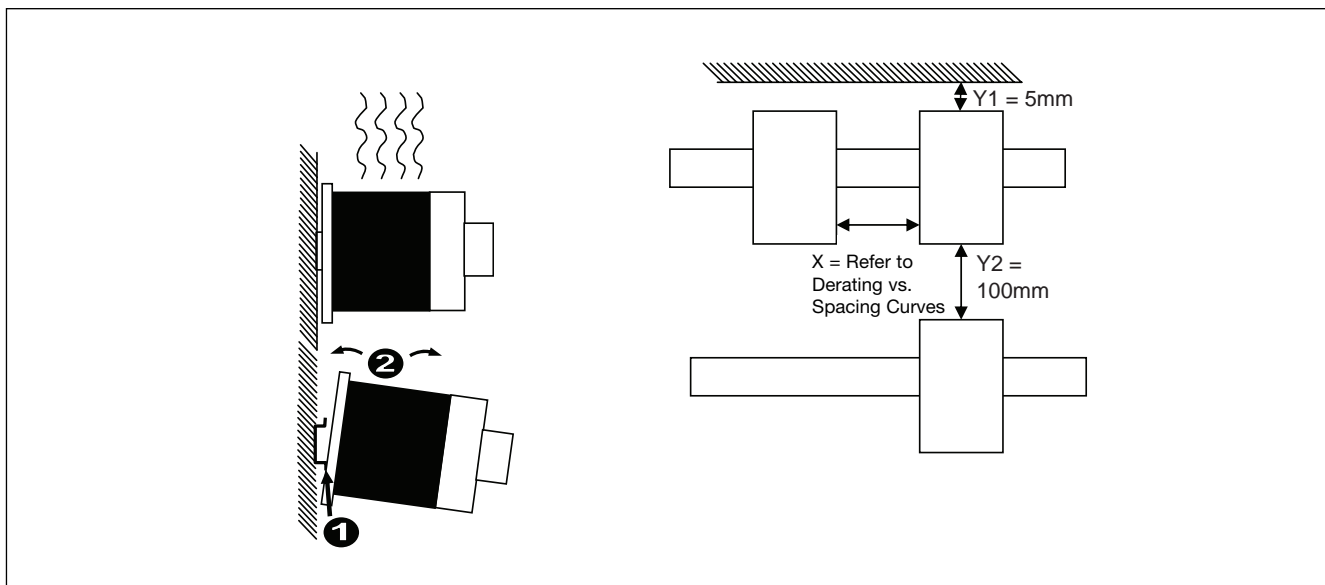

## Short Circuit Protection

### Protection Co-ordination, Type 1 vs Type 2:

Type 1 protection implies that after a short circuit, the device under test will no longer be in a functioning state. In type 2 co-ordination the device under test will still be functional after the short circuit. In both cases, however the short circuit has to be interrupted. The fuse between enclosure and supply shall not open. The door or cover of the enclosure shall not be blown open. There shall be no damage to conductors or terminals and the conductors shall not separate from terminals. There shall be no breakage or cracking of insulating bases to the extent that the integrity of the mounting of live parts is impaired. Discharge of parts or any risk of fire shall not occur.

The product variants listed in the table hereunder are suitable for use on a circuit capable of delivering not more than 100,000A rms Symmetrical Amperes, 600 Volts maximum when protected by fuses. Tests at 100,000A were performed with Class J fuses, fast acting; please refer to the table below for maximum allowed ampere rating of the fuse. Use fuses only.

### Co-ordination type 1 (UL508)

Part No.	Max. size [A]	Class	Current [kA]	Voltage [VAC]
RGC..15	30	J	100	Max. 600
RGC..20	30	J	100	Max. 600
RGC..30	30	J	100	Max. 600
RGC..40	30	J	100	Max. 600
RGC..60	30	J	100	Max. 600
RGC..90GGEP	40	J	100	Max. 600

### Co-ordination type 2 (IEC EN 60947-4-2/ -4-3)

Part No.	Ferraz Shawmut		Siba		Current [kA]	Voltage [VAC]
	Max size [A]	Part number	Max size [A]	Part number		
RGC..15	32	6.9xx CP URD 22x58/32 (xx=00 or 21)	32	50 142 06.32	100	Max. 600
RGC..20	32	6.9xx CP URD 22x58/32 (xx=00 or 21)	32	50 142 06.32	100	Max. 600
RGC..30	40	A70QS40-4	32	50 142 06.32	100	Max. 600
RGC..40	70	A70QS70-4	63	50 194 20.63	100	Max. 600
RGC..60	90	A70QS90-4	80	50 194 20.80	100	Max. 600
RGC..90GGEP	100	A70Q5100-4	100	50 194 20.100	100	Max. 600

## Protection with Miniature Circuit Breakers

Solid State Relay type	Model no. for Z - type M. C. B. (rated current)	Model no. for B - type M. C. B. (rated current)	Wire cross sectional area [mm <sup>2</sup> ]	Minimum length of Cu wire conductor [m] <sup>13</sup>	
<b>RGC..15, RGC..20</b>	S201 - Z4 (4A)	S201 - B2 (2A)	1.0	21.0	
	S201 - Z6 UC (6A)	S201 - B2 (2A)	1.0	21.0	
			1.5	31.5	
<b>RGC..30</b>	S201 - Z10 (10A)	S201-B4 (4A)	1.0	7.6	
			1.5	11.4	
			2.5	19.0	
	S201 - Z16 (16A)	S201-B6 (6A)	1.0	5.2	
			1.5	7.8	
			2.5	13.0	
			4.0	20.8	
	S201 - Z20 (20A)	S201-B10 (10A)	1.5	12.6	
			2.5	21.0	
	S201 - Z25 (25A)	S201-B13 (13A)	2.5	25.0	
			4.0	40.0	
	S202 - Z25 (25A)	S202-B13 (13A)	2.5	19.0	
			4.0	30.4	
	<b>RGC..40</b>	S201 - Z25 (25A)	S201-B13 (13A)	2.5	7.0
				4.0	11.2
6.0				16.8	
<b>RGC..60</b>	S201 - Z25 (25A)	S201-B13 (13A)	2.5	7.0	
			4.0	11.2	
			6.0	16.8	
<b>RGC..90GGEP</b>	S201 - Z20 (20A)	S201-B10 (10A)	1.5	4.2	
			2.5	7.0	
			4.0	11.2	
	S202 - Z20 (20A)	S202-B10 (10A)	1.5	1.8	
			2.5	3.0	
			4.0	4.8	
	S201 - Z32 (32A)	S201-B16 (16A)	2.5	13.0	
			4.0	20.8	
			6.0	31.2	
	S202 - Z32 (32A)	S202-B16 (16A)	2.5	5.0	
			4.0	8.0	
			6.0	12.0	
			10.0	20.0	
	S202 - Z50 (50A)	S202-B25 (25A)	4.0	14.8	
			6.0	22.2	
			10.0	37.0	

13. between MCB and SSR Relay (including return path which goes back to the mains).

Note: A prospective current of 6kA and a 230/400V power supply system is assumed for the above suggested specifications. For cables with different cross section than those mentioned above please consult Carlo Gavazzi's Technical Support Group.